



## IDM1xx Hand-held Scanners

Flexible and reliable identification of bar codes

## Control at your fingertips: mobile identification with IDM1xx

**SICK offers hand-held scanners for use in a wide range of applications. Identification tasks can be carried out simply, flexibly and reliably using these easy-to-use devices.**

### Reliable reading performance

The IDM hand-held scanners have high-performance image capture modules. Even damaged or poorly printed bar codes can be reliably detected.

- ▶ **Reduced need for manual reinput**

### Ergonomic design

All IDM hand-held scanners are characterized by their ergonomically shaped housing. Along with their low weight, the devices fit well in the user's hand and can be easily operated.

- ▶ **Comfortable, effortless operation**

### High reading speed

Scanning rates of up to 500 scans/second ensure high throughput. The highly visible scan line allows the operator to intuitively locate and align the code, which accelerates the scanning process.

- ▶ **Significantly increased productivity**

### Standardized configuration

A standardized and comprehensive configuration concept unites all IDM hand-held scanners by means of codes or software. This allows reading to be narrowed down to desired code types, code lengths and even content.

- ▶ **Quick and intuitive commissioning**





## Integration into industrial fieldbuses

In addition to connecting them directly to common PC interfaces, such as USB and RS-232, IDM hand-held scanners can also be integrated into networks using special connection modules (see page 27 onwards). With SICK as a system supplier of complete identification solutions, it is also possible to interconnect these scanners with fixed 1D or 2D reading devices from SICK.

- ▶ **Plant flexibility**

## Variable accessories

Whether you need holders or stands, the accessories for IDM hand-held scanner can be easily implemented. Only a single power supply is needed for all versions, making it particularly practical. It can be used worldwide because country-specific adapters are all already included. Connecting cables can be adapted to meet specific customer requests.

- ▶ **High availability, low storage costs**

## Global support

With nearly 50 subsidiaries in all major industrial nations as well as numerous representatives, we're there where you need us. You are not on your own.

- ▶ **Quick support before and after your purchase**

## Versions for all situations

Ranging from the simple office scanner to the rugged industrial version, the IDM hand-held scanners provide a tailored solution for all requirements and industries.

- ▶ **Tailored price/performance ratio**



## IDM120, IDM140 or IDM160 – It's your choice

At SICK, you can find exactly the right model for your requirements at an optimal price/performance ratio, from the wired scanner for standard applications to the wireless top model suitable for industrial applications.



### “Industrial” scanner

- Increased productivity and throughput thanks to fast and reliable identification
- Easy to use through long range and immediate reading
- High reliability thanks to industrial grade and rugged housing
- Intuitive good read feedback for noisy industrial environment via vibration, beeper and LED
- Reduced costs thanks 2 in 1 scan engine: covering standard and high density codes with a single device
- Tool-free cable and battery changing
- Can be mounted onto industrial spring balancers for ergonomic workstations



### “General purpose” scanner



















- For standard applications
- Reliable identification at a low price
- High user comfort due to ergonomic housing and low weight
- Reduced costs thanks 2 in 1 scan engine: covering standard and high density codes with a single device

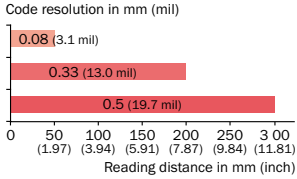
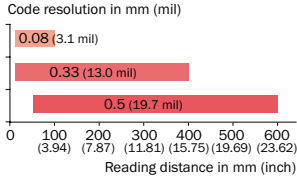
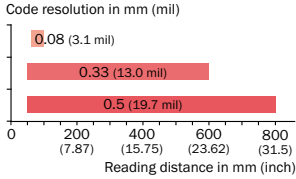

### “Wireless” scanner

- Maximum freedom of movement in the workstation without limiting cables
- Choice between Bluetooth® and WLAN
- Large radio ranges and intermediate-storage function for up to 20,000 codes
- Highly visible color display in WLAN versions for comfortable operation
- Pre-designed inventory function for interlinking article information and quantity
- Long-lasting and high-performance lithium-ion batteries

## Product comparison

			
	<b>IDM120</b>	<b>IDM140</b>	<b>IDM160</b>
<b>Application</b>			
<b>Code types</b>	 	 	 
<b>Reading-field diagrams</b>	<p>Code resolution in mm (mil)</p>  <p>Reading distance in mm (inch)</p>	<p>Code resolution in mm (mil)</p>  <p>Reading distance in mm (inch)</p>	<p>Code resolution in mm (mil)</p>  <p>Reading distance in mm (inch)</p>
<b>Enclosure rating</b>			
<b>Wireless versions</b>	-	 Bluetooth® + WLAN	 Bluetooth® + WLAN
<b>Cable/battery change without the need for additional tools</b>	-	-	

Tailored solutions for  
a wide range of applications

Data must be detected quickly and flexibly across different industries. The use of SICK's hand-held scanners enables impeccable reading results in a matter of seconds. Increased efficiency makes its mark in every department – from the office to delivery.



## Factory automation

A well-organized and efficient production flow plays an important role for the competitiveness of a company. Hand-held scanners identify codes on documents, components or finished parts, which in turn helps to speed up production processes and prevent errors. Combined with database systems, the demand for comprehensive traceability is also met.



## Logistics automation

The demand for faster material movement requires more efficient control mechanisms. Quick and flexible identification using hand-held scanners is ideal. Whether in a manual small-parts warehouse or in an automated logistics center, thanks to wired or radio-based devices, you always have everything under control.



## Additional areas of application

Hand-held scanners also provide impeccable reading results in many other applications in a matter of seconds. In the office, at the checkout or even in the laboratory – reliable and quick process flows would not be possible nowadays without the use of automatic scanners.





Product family overview



**IDM120**

The entry level scanner

Technical data overview

Scanner design	Linear hand-held image scanner
Scanning frequency	250 Hz
Code resolution	≥ 0.076 mm
Reading distance	0 mm ... 200 mm (0.5 mm)
Supported code type	1D, Stacked
Serial	✓
Ethernet	- , optional via external connection module (CDM + CMF)
CAN bus	- , optional via external connection module (CAN232)
PROFIBUS	- , optional via external connection module (CDF)
ProfiNet	- , optional via external connection module (CDM425)
DeviceNet	- , optional via external connection module (CDM + CMF)
PS/2	✓
USB	✓
Bluetooth	-
WLAN	-

At a glance



- Reading from contact up to 20 cm
- Identification of all popular 1D codes, with PDF version also stacked codes
- Scan rate up to 250 scans/second
- Withstands 25 drops from 1.5 m height
- Extremely lightweight, only 130 g
- PS/2 and USB or RS-232 TTL connectivity
- Highly visible scan line
- IP 41 enclosure rating

Detailed information

→ 10





**IDM140**











Versatility made easy – from high density to standard range codes



**IDM160**

Industrial mobile reliability

Linear hand-held image scanner	Linear hand-held image scanner
500 Hz	500 Hz
≥ 0.076 mm	≥ 0.076 mm
50 mm ... 600 mm (0.5 mm)	50 mm ... 800 mm (0.5 mm)
1D, Stacked	1D, Stacked
✓	✓
–, optional via external connection module (CDM + CMF)	–, optional via external connection module (CDM + CMF)
–, optional via external connection module (CAN232)	–, optional via external connection module (CAN232)
–, optional via external connection module (CDF)	–, optional via external connection module (CDF)
–, optional via external connection module (CDM425)	–, optional via external connection module (CDM425)
–, optional via external connection module (CDM + CMF)	–, optional via external connection module (CDM + CMF)
✓	✓
✓	✓
✓	✓
✓	✓

    	     
<ul style="list-style-type: none"> <li>• Reading distance up to 600 mm</li> <li>• Identification of all popular 1D codes, with PDF version also stacked codes</li> <li>• High throughput with up to 500 scans/second</li> <li>• Withstands 25 drops from 1.8 m height</li> <li>• Highly visible scan line</li> <li>• IP 41 enclosure rating</li> <li>• Corded and cordless versions available</li> </ul>	<ul style="list-style-type: none"> <li>• Identification of all popular 1D codes, with PDF version also stacked codes</li> <li>• Reading distance up to 800 mm (at 0.5 mm)</li> <li>• Identification of standard and high-density codes (0.076 mm)</li> <li>• High throughput with up to 500 scans/sec.</li> <li>• Compact housing with up to IP 65 withstanding 50 drops from 2 m on concrete</li> <li>• Good read feedback via LED, beeper and vibrator</li> <li>• Supports all popular corded and cordless interfaces as well as industrial fieldbuses via SICK connectivity</li> <li>• Tool-free exchange of cable and battery</li> <li>• Corded and cordless versions available</li> </ul>
→ 14	→ 20

The entry level scanner



General Purpose 	1D 	Stacked 	Enclosure rating <b>IP41</b>
---------------------	--------	-------------	---------------------------------



Product description

The IDM120 is a price attractive solution for standard reading applications. In contrast to similar products, IDM120 is not a pure touch reader. It can also identify bar codes up to 20 cm distance and up to 120 mm width. Combined with a scan rate of 250 scans/second IDM120 helps to shorten reading time and increase throughput. The ergonomic design with two side trigger for both left and right handed users plus the low weight makes

it comfortable for daily use. The IDM120 is IP 41 rated and withstands multiple drops from 1.5 m height. All common interfaces such as PS/2, USB or RS-232 are supported.

This combination of performance and easy to use, paired with attractive price, makes the IDM120 an all-round device for simple applications within point-of-sales, medial of office automation

At a glance

- Reading from contact up to 20 cm
- Identification of all popular 1D codes, with PDF version also stacked codes
- Scan rate up to 250 scans/second
- Withstands 25 drops from 1.5 m height
- Extremely lightweight, only 130 g
- PS/2 and USB or RS-232 TTL connectivity
- Highly visible scan line
- IP 41 enclosure rating

Your benefits

- Designed for contact and close-range detection, providing flexible operation
- Increased productivity thanks to short scan time
- Low-cost solution for identifying various code sizes
- Trigger buttons on both sides make it suitable for left- and right-handed operation
- Lightweight, ergonomic design ensures user comfort
- The most popular industrial interfaces allow flexible connectivity to, e.g., PS/2, USB and RS-232 TTL
- Easy targeting with highly visible scan line for correct aiming
- Reliable identification reduces the need to manually input data



Additional information

Detailed technical data..... 10

Ordering information..... 12

Reading field diagrams..... 12

Accessories..... 18

Connection options..... 26

## Detailed technical data

### Features

Scanner design	Linear hand-held image scanner
Light source	Visible red light (660 nm)
Scanning frequency	≤ 250 Hz
Code resolution	≥ 0.076 mm
Reading distance (at code resolution)	0 mm ... 200 mm (0.5 mm)
Reading field (at distance)	120 mm (150 mm)

### Performance

Supported code type	1D / Stacked (depending on type)
Bar code types	Code 39, Code 32, HIBC, Code 93, Code 11, Codabar, Code 128, UCC/EAN-128, UPC-A, UPC-E, MSI/Plessey, UK/Plessey, IATA, Standard and Industrial 2 of 5, Matrix 2 of 5, Interleaved 2 of 5, Mainland China Postal Code, German ITF Postal Code, Telepen, Limited/Expanded GS1 DataBar, PDF417, MicroPDF417, Codablock, Composite (depending on type)

### Interfaces

Serial	Function	✓ RS-232 TTL
Ethernet		-, optional via external connection module (CDM + CMF)
CAN bus		-, optional via external connection module (CAN232)
PROFIBUS		-, optional via external connection module (CDF)
ProfiNet		-, optional via external connection module (CDM425)
DeviceNet		-, optional via external connection module (CDM + CMF)
PS/2	Function	✓ Keyboard wedge
USB	Function	✓ Keyboard wedge, COM-Port Emulation
Optical indicators		2 LEDs (operational status, good read)
Acoustic indicators		Beeper, disengageable (good read)
Vibration		No

### Mechanics/electronics

Operating voltage	5 V DC, ± 5 %
Housing color	Black
Enclosure rating	IP 41
Weight	130 g, without cable
Dimensions	230 mm x 170 mm x 100 mm

### Ambient data

Shock resistance	25 drops from 1.5 m height on concrete
Ambient operating temperature	0 °C ... +50 °C
Storage temperature	-20 °C ... +60 °C
Permissible relative humidity	95 %, on-condensing
Ambient light safety	10,000 lx

## Ordering information

- **Field of application:** general purpose
- **Type:** Short Range

	Items supplied	Model name	Part no.
Single scanner	Hand-held scanner, quick start guide	IDM120-201B	6040981 <sup>1)</sup>
Kit	Kit contains hand-held scanner, interface cable and quick start guide	IDM120-2 PS/2 Kit	6040978
	Kit contains hand-held scanner, interface cable and quick start guide	IDM120-2 USB Kit	6040979
	Kit contains hand-held scanner, interface cable, power supply and quick start guide	IDM120-2 RS-232 Power Supply Kit	6041016
Single scanner	Hand-held scanner, quick start guide	IDM120-2PDF01B	6041192 <sup>1)</sup>
Kit	Kit contains hand-held scanner, interface cable and quick start guide	IDM120-2PDF PS/2 Kit	6041186
	Kit contains hand-held scanner, interface cable and quick start guide	IDM120-2PDF USB Kit	6041189
	Kit contains hand-held scanner, interface cable, power supply and quick start guide	IDM120-2PDF RS-232 Power Supply Kit	6044887

<sup>1)</sup> Required accessories: power supply (if required), cable.



## Reading field diagrams

---

### IDM120 Standard Short Range

Code resolution in mm (mil)

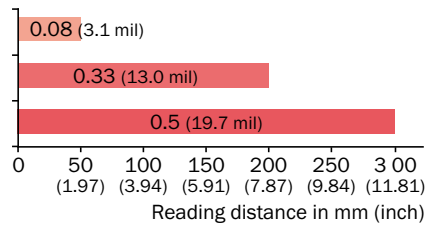

## Accessories

---

**Accessories for IDM120 see page 18.**

**Fore more information on connectivity see page 26.**

Versatility made easy – from high density to standard range codes



General Purpose 	1D 	Stacked 	Enclosure rating <b>IP41</b>
Wireless 			



### Product description

IDM140 offers high flexibility. The device is able to read all popular 1D bar codes but also stacked codes such as PDF417. Ergonomic design and low weight makes it comfortable to work with IDM140 scanners. For more mobility wireless Bluetooth or WLAN versions are available. All versions have a linear

imaging sensor integrated able to read in up to 600 mm distance. Badly printed or damaged codes are no problem anymore. The IDM140 series combines reading performance and flexible choice of corded and cordless versions. It helps solving various tasks inside office, factory or logistics automation.

### At a glance

- Reading distance up to 600 mm
- Identification of all popular 1D codes, with PDF version also stacked codes
- Scan rate up to 500 scans/second
- Withstands 25 drops from 1.8 m height
- Highly visible scan line
- IP 41 enclosure rating

### Your benefits

- Increased productivity thanks to high scan rate
- Reliable identification reduces the need to manually input data
- Lightweight, ergonomic design ensures user comfort
- Highly dependable thanks to rugged housing and non-moving parts
- Easy targeting with highly visible scan line for correct aiming



### Additional information

Detailed technical data.....	15
Ordering information.....	17
Reading field diagrams.....	17
Accessories.....	18
Connection options.....	26

## Detailed technical data

### Features

Scanner design	Linear hand-held image scanner
Light source	Visible red light (630 nm)
Scanning frequency	≤ 500 Hz
Code resolution	≥ 0.076 mm
Reading distance (at code resolution)	50 mm ... 600 mm (0.5 mm)
Reading field (at distance)	150 mm (200 mm)

### Performance

	IDM140 Standard	IDM140 Bluetooth	IDM140 WLAN
Supported code type	1D / Stacked (depending on type)		
Bar code types	Codabar, Code 39, Code 32, UPC-A, UPC-E, Standard and Industrial 2 of 5, Interleaved & Matrix 2 of 5, Code 128, UCC/EAN-128, Code 11, Code 93, German ITF Postal Code, Mainland China Postal Code, Telepen, MSI/Plessey, UK/Plessey, Limited/Expanded GS1 DataBar, PDF417, MicroPDF417, Codablock, Composite (depending on type)		
Battery power	-	Over 45,000 scans with full battery	
Code buffer	-	5000 Codes (EAN)	-

### Interfaces

	IDM140 Standard	IDM140 Bluetooth	IDM140 WLAN
Serial	✓		-
Function	RS-232 TTL		-
Ethernet	-, optional via external connection module (CDM + CMF)		-
CAN bus	-, optional via external connection module (CAN232)		-
PROFIBUS	-, optional via external connection module (CDF)		-
ProfiNet	-, optional via external connection module (CDM425)		-
DeviceNet	-, optional via external connection module (CDM + CMF)		-
PS/2	✓		-
Function	Keyboard wedge		-
USB	✓		-
Function	Keyboard wedge, COM-Port Emulation		-
Bluetooth	-	✓	-
Function	-	Wireless operating range up to 30 m (free view), batch function for expansion of the wireless radius	-
Protocol	-	Bluetooth™ V2.1 EDR, 2.4 ... 2.4835 GHz	-
WLAN	-		✓
Protocol	-		IEEE 802.11 b/g
Encryption (WLAN)	-		WEP, WPA, WPA2
Optical indicators	2 LEDs (operational status, good read)	2 LEDs (good read, charge of battery, radio connection status)	1 LED, display
Acoustic indicators	Beeper, disengageable (good read)		
Vibration	No		

## Mechanics/electronics

	IDM140 Standard	IDM140 Bluetooth	IDM140 WLAN
<b>Operating voltage</b>	5 V DC, ± 5 %		
<b>Housing color</b>	Black/gray		
<b>Enclosure rating</b>	IP 41		
<b>Weight</b>	160 g, without cable	230 g, incl. rechargeable battery	
<b>Dimensions</b>	97.8 mm x 70.5 mm x 156.2 mm		

## Ambient data

<b>Shock resistance</b>	25 drops from 1.8 m height on concrete
<b>Ambient operating temperature</b>	0 °C ... +50 °C
<b>Storage temperature</b>	-40 °C ... +70 °C
<b>Permissible relative humidity</b>	95 %, non-condensing
<b>Ambient light safety</b>	100,000 lx



## Ordering information

- **Field of application:** general purpose
- **Type:** Mid Range

Sub product family	Field of application	Items supplied		Model name	Part no.
IDM140 Standard	General purpose	Single scanner	Hand-held scanner, quick start guide	IDM140-201D	6040985 <sup>1)</sup>
				IDM140-2PDF01D	6040989 <sup>1)</sup>
		Kit	Kit contains hand-held scanner, interface cable and quick start guide	IDM140 PS/2 Kit	6040982
			Kit contains hand-held scanner, interface cable and quick start guide	IDM140 RS-232 Kit	6041017
			Kit contains hand-held scanner, interface cable and quick start guide	IDM140 USB Kit	6040983
			Kit contains hand-held scanner, interface cable and quick start guide	IDM140PDF PS/2 Kit	6040986
			Kit contains hand-held scanner, interface cable, power supply and quick start guide	IDM140PDF RS-232 Kit	6041018
Kit contains hand-held scanner, interface cable and quick start guide	IDM140PDF USB Kit	6040987			
IDM140 Bluetooth	General purpose, cordless	Single scanner	Cordless scanner and battery is included in delivery	IDM140-2BT	6036729 <sup>2)</sup>
				IDM140-2PDFBT	6036730 <sup>2)</sup>
		Kit	Kit contains cordless scanner, battery, charging station and power supply	IDM140BT Charging Kit	6040993
			Kit contains cordless scanner, battery, base station, interface cable, power supply and quick start guide	IDM140BT PS/2 Kit	6040990
				IDM140BT RS232 Kit	6040992
				IDM140BT USB Kit	6040991
			Kit contains cordless scanner, battery, charging station and power supply	IDM140PDF BT Charging Kit	6040997
			Kit contains cordless scanner, battery, base station, interface cable, power supply and quick start guide	IDM140PDF BT PS/2 Kit	6040994
				IDM140PDF BT RS-232 Kit	6040996
				IDM140PDF BT USB Kit	6040995
IDM140 WLAN	General purpose, cordless	Single scanner	Cordless scanner and battery is included in delivery	IDM140-2PDF WLAN12D	6043434 <sup>3)</sup>
				IDM140-2WLAN12D	6043433 <sup>3)</sup>
		Kit	Kit contains cordless scanner, battery, charging station, USB cable, power supply and quick start guide	IDM140PDF WLAN Kit	6043432
				IDM140 WLAN Kit	6043431

<sup>1)</sup> Required accessories: power supply (if required), cable.

<sup>2)</sup> Required accessories: cable (if required), base or charging station (if required).

<sup>3)</sup> Required accessories: charging station and power supply unit.

## Reading field diagrams

### IDM140 Standard

### IDM140 Bluetooth

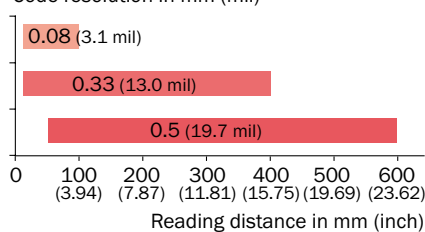

### IDM140 WLAN Mid Range

Code resolution in mm (mil)









## Accessories for IDM120 and IDM140

### Other mounting accessories

	Brief description	Model name	Part no.	IDM120	IDM140 Standard	IDM140 Bluetooth	IDM140 WLAN
	Countertop stand	Countertop stand	6036724	-	●	●	-
	Desk holder	Desk holder	6036723	●	●	●	-

### Plug connectors and cables



	Brief description	Model name	Part no.	IDM120	IDM140 Standard	IDM140 Bluetooth	IDM140 WLAN
	Straightened RS-232 TTL cable, 1.8 m, additional power supply needed	Connection cable (plug-socket)	6036727	●	●	●	-
	Straightened RS-232 TTL cable, 1.8 m, power via pin 9 or power supply unit	Connection cable (plug-socket)	6041540	●	●	●	-
	Straightened PS/2 cable, 2 m	Connection cable (plug-plug)	6036726	●	●	●	-
	Straightened USB cable, 1.8 m	Connection cable (plug-plug)	6036728	●	●	●	●
	Spiral cord PS/2 3.8 m (fully extracted)	Connection cable (plug-plug)	6039155	●	●	●	-
	Spiral cord RS-232 3.8 m (fully extracted), power via pin 9 or power supply unit	Connection cable (plug-plug)	6039156	●	●	●	-
	Spiral cord USB 3.8 m (fully extracted)	Connection cable (plug-plug)	6039158	●	●	●	●

For more information on connectivity see page 26.

## Power supply units

	Brief description	Model name	Part no.	IDM120	IDM140 Standard	IDM140 Bluetooth	IDM140 WLAN
	Power supply unit, input AC 100 ... 240 V, output DC 5 V/2 A	Power supply unit	6036722	●	●	●	●

## Rechargeable batteries and battery chargers

	Brief description	Model name	Part no.	IDM120	IDM140 Standard	IDM140 Bluetooth	IDM140 WLAN
	Radio base station; operating voltage 5 V DC, operating power max. 650 mA	Base station	6041267	-	-	●	-
	Lithium-ion replacement battery for the radio scanners IDM140-2 Bluetooth	Replacement battery	6041193	-	-	●	●
	Charging station without Bluetooth functionality; operating voltage 5 V DC, operating power max. 650 mA	Charging station	6041266	-	-	●	●

## Industrial mobile reliability



Industrial	1D	Stacked	Enclosure rating <b>IP65</b>
Wireless	Tool-free		



### Product description

The IDM160 offers high performance barcode reading with its rugged, industrial, and ergonomic housing. The IP 65 enclosure rating ensures protection against dust and water jets. It can withstand 50 drops from 2 m on concrete. Its ergonomic design and low weight as well as quick integration in common indus-

trial networks guarantee maximum user comfort. Thanks to Bluetooth and WLAN version, flexibility and mobility is guaranteed. The IDM160 series is the ideal choice to increase productivity within industrial factory and logistics automation applications.

### At a glance

- Identification of all popular 1D codes, with PDF version also stacked codes
- Reading distance up to 800 mm (at 0.5 mm)
- Identification of standard and high-density codes (0.076 mm)
- High throughput with up to 500 scans/sec.
- Compact housing with up to IP 65 withstanding 50 drops from 2 m on concrete
- Good read feedback via LED, beeper and vibrator
- Supports all popular corded and cordless interfaces as well as industrial fieldbuses via SICK connectivity
- Tool-free exchange of cable and battery
- Corded and cordless versions available

### Your benefits

- Increased productivity and throughput thanks to fast and reliable identification
- Reduced costs thanks to 2-in-1 scan engine: covering standard and high-density codes with a single device
- High reliability thanks to industrial grade and rugged housing
- Easy to use through long range and immediate reading
- Intuitive good read feedback for noisy industrial environment via vibration, beeper and LED
- Higher user comfort through ergonomic housing design, well balanced and light weight
- High flexibility and operator mobility with corded and cordless versions
- Quick integration in most corded and cordless PC or industrial networks
- SICK LifeTime Services give you peace of mind



### Additional information

Detailed technical data.....	21
Ordering information.....	22
Reading field diagrams.....	23
Accessories.....	24
Connection options.....	26



## Detailed technical data

### Features

	IDM160 Standard	IDM160 Bluetooth	IDM160 WLAN
Scanner design	Linear hand-held image scanner		
Light source	Visible red light (630 nm)		
Scanning frequency	≤ 500 Hz		
Code resolution	≥ 0.076 mm		
Reading distance (at code resolution)	50 mm ... 800 mm (0.5 mm)		
Reading field (at distance)	200 mm (200 mm)		

### Performance

	IDM160 Standard	IDM160 Bluetooth	IDM160 WLAN
Supported code type	1D / Stacked (depending on type)		
Bar code types	Codabar, Code 39, Code 32, UPC-A, UPC-E, Standard and Industrial 2 of 5, Interleaved & Matrix 2 of 5, Code 128, UCC/EAN-128, Code 11, Code 93, German ITF Postal Code, Mainland China Postal Code, Telepen, MSI/Plessey, UK/Plessey, Limited/Expanded GS1 DataBar, PDF417, MicroPDF417, Codablock, Composite (depending on type)		
Battery power	-	Over 45,000 scans with full battery	
Code buffer	-	5000 Codes (EAN)	-

### Interfaces

	IDM160 Standard	IDM160 Bluetooth	IDM160 WLAN
Serial	✓		-
	Function	RS-232 TTL	-
Ethernet	-, optional via external connection module (CDM + CMF)		-
CAN bus	-, optional via external connection module (CAN232)		-
PROFIBUS	-, optional via external connection module (CDF)		-
ProfiNet	-, optional via external connection module (CDM425)		-
DeviceNet	-, optional via external connection module (CDM + CMF)		-
PS/2	✓		-
	Function	Keyboard wedge	-
USB	✓		-
	Function	Keyboard wedge, COM-Port Emulation	-
Bluetooth	Function	-	-
	Protocol	✓	-
WLAN	Function	Wireless operating range up to 30 m (free view), batch function for expansion of the wireless radius	-
	Protocol	Bluetooth™ V2.1 EDR, 2.4 ... 2.4835 GHz	-
Encryption (WLAN)	-		✓
Optical indicators	2 LEDs (operational status, good read)	2 LEDs (good read, charge of battery, radio connection status)	1 LED, display
Acoustic indicators	Beeper, disengageable (good read)		Beeper, disengageable
Vibration	Yes		

## Mechanics/electronics

	IDM160 Standard	IDM160 Bluetooth	IDM160 WLAN
Operating voltage	5 V DC, ± 5 %		
Housing color	Blue, gray		
Enclosure rating	IP 65		IP 64
Weight	200 g, without cable	266 g, incl. rechargeable battery	275 g, incl. rechargeable battery
Dimensions	104 mm x 76 mm x 185 mm		

## Ambient data

	IDM160 Standard	IDM160 Bluetooth	IDM160 WLAN
Shock resistance	50 drops from 2 m height on concrete		
Ambient operating temperature	-20 °C ... +50 °C		-10 °C ... +50 °C
Storage temperature	-30 °C ... +70 °C		
Permissible relative humidity	95 %, non-condensing		
Ambient light safety	100,000 lx		

## Ordering information

- Field of application: industrial
- Type: Long Range

Sub product family	Field of application	Items supplied	Model name	Part no.
IDM160 Standard	Industrial	Single scanner	Hand-held scanner, quick start guide	IDM160-01E 6045078 <sup>1)</sup>
				IDM160-PDF01E 6045081 <sup>1)</sup>
		Kit	Kit contains hand-held scanner, interface cable and quick start guide	IDM160 PS/2 Kit 6045076
			Kit contains hand-held scanner, interface cable, power supply and quick start guide	IDM160 RS-232 Power Supply Kit 1056245
			Kit contains hand-held scanner, interface cable and quick start guide	IDM160 USB Kit 6045058
				IDM160PDF PS/2 Kit 6045079
			Kit contains hand-held scanner, interface cable, power supply and quick start guide	IDM160PDF RS-232 Power Supply Kit 1056246
			Kit contains hand-held scanner, interface cable and quick start guide	IDM160PDF USB Kit 6045059
Set	Set contains hand-held scanner, interface cable, CDF600 and quick start guide	IDM160 CDF600 Profibus Set 1056248		
IDM160 Bluetooth	Cordless, industrial	Single scanner	Cordless scanner and battery is included in delivery	IDM160-BT11E 6045085 <sup>2)</sup>
				IDM160-PDFBT11E 6045088 <sup>2)</sup>
		Kit	Kit contains cordless scanner, battery, base station, interface cable, power supply and quick start guide	IDM160BT PS/2 Kit 6045082
				IDM160BT RS-232 Kit 6045083
				IDM160BT USB Kit 6045060
				IDM160PDF BT PS/2 Kit 6045086
				IDM160PDF BT RS-232 Kit 6045087
				IDM160PDF BT USB Kit 6045061

Sub product family	Field of application	Items supplied		Model name	Part no.
IDM160 WLAN	Cordless, industrial	Single scanner	Cordless scanner and battery is included in delivery	IDM160-WLAN12E	6047650 <sup>3)</sup>
				IDM160-PDF WLAN12E	6047651 <sup>3)</sup>
		Kit	Kit contains cordless scanner, battery, charging station, USB cable, power supply and quick start guide	IDM160 WLAN Kit	6045062
				IDM160PDF WLAN Kit	6045063

<sup>1)</sup> Required accessories: power supply (if required), cable.

<sup>2)</sup> Required accessories: cable (if required), base or charging station (if required).

<sup>3)</sup> Required accessories: charging station and power supply unit.

## Reading field diagrams

### IDM160 Standard

### IDM160 Bluetooth

### IDM160 WLAN Long Range

Code resolution in mm (mil)

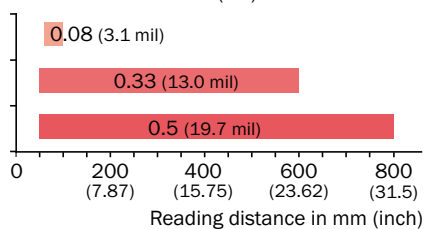









## Accessories

### Other mounting accessories

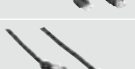
	Brief description	Model name	Part no.	IDM160 Standard	IDM160 Bluetooth	IDM160 WLAN
	Countertop stand	Countertop stand	6045193	●	●	-
	Desk holder	Desk holder	6045192	●	●	●

### Plug connectors and cables



	Brief description	Model name	Part no.	IDM160 Standard	IDM160 Bluetooth	IDM160 WLAN
	Straightened RS-232 TTL cable, 1.8 m, power via pin 9 or power supply unit	Connection cable (plug-socket)	6041540	-	●	-
	Straightened RS-232 TTL cable, 1.8 m, power via pin 9 or power supply unit	Connection cable (plug-socket)	6045196	●	-	-
	Straightened PS/2 cable, 2 m	Connection cable (plug-plug)	6036726	-	●	-
	Straightened PS/2 cable, 2 m	Connection cable (plug-plug)	6045194	●	-	-
	Straightened USB cable, 1.8 m	Connection cable (plug-plug)	6036728	-	●	●
	Straightened USB cable, 1.8 m	Connection cable (plug-plug)	6045195	●	-	-
	Spiral cord RS-232 TTL 3.8 m (fully extracted), power via pin 9 or power supply unit	Connection cable (plug-plug)	6045233	●	-	-
	Spiral cord PS/2 3.8 m (fully extracted)	Connection cable (plug-plug)	6045231	●	-	-
	Spiral cord USB 3.8 m (fully extracted)	Connection cable (plug-plug)	6045232	●	-	-

For more information on connectivity see page 26.

## Power supply units

	Brief description	Model name	Part no.	IDM160 Standard	IDM160 Bluetooth	IDM160 WLAN
	Power supply unit, input AC 100 ... 240 V, output DC 5 V/2 A	Power supply unit	6036722	●	●	●

## Rechargeable batteries and battery chargers

	Brief description	Model name	Part no.	IDM160 Standard	IDM160 Bluetooth	IDM160 WLAN
	Radio base station; operating voltage 5 V DC	Base station	6045197	-	●	-
	Lithium-ion replacement battery for the radio scanners IDM160 Bluetooth	Replacement battery	6041193	-	●	●
	Charging station without Bluetooth functionality; operating voltage 5 V DC	Charging station	6045198	-	●	●

## Connection options and integration into fieldbuses

Alongside the usual connection options via USB, PS/2 or RS232, SICK hand-held scanners can be integrated into industrial fieldbuses, such as the PROFIBUS, ProfiNet or Ethernet, using SICK fieldbus gateways. Integration with fixed reading devices like the CLV6xx or LECTOR® is also possible.



### Direct connection to a PC

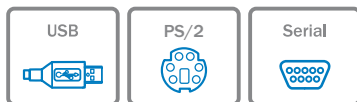

In order to connect an IDM1xx hand-held scanner directly to a PC, the following is required:

- Connection cable for IDM120/IDM140, see page 18.
- Connection cable for IDM160, see page 24.

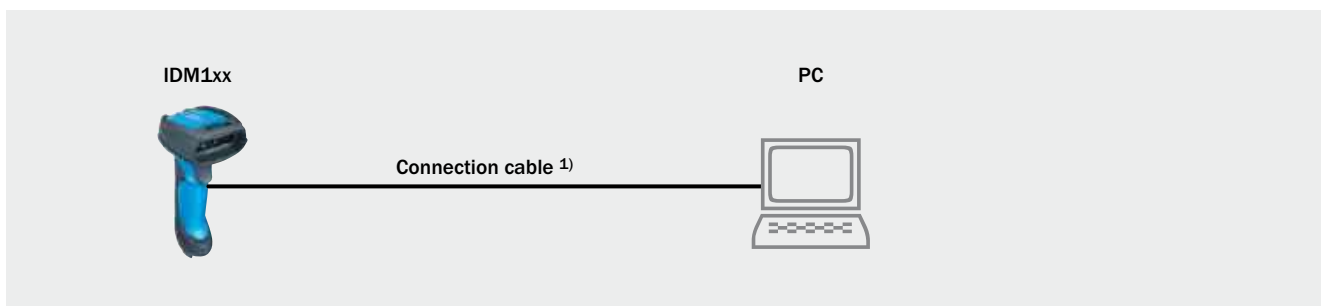

<sup>1)</sup> RS232 connection may require a power supply or voltage via pin 9.



## Connection to a network

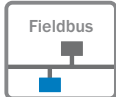

In order to connect an IDM1xx hand-held scanner to a network, the following is required:

- Adapter cable, see page 28.
- Connection cable, see page 28.
- Connection module, see page 29.

### Example of connection to PROFIBUS using CDF600

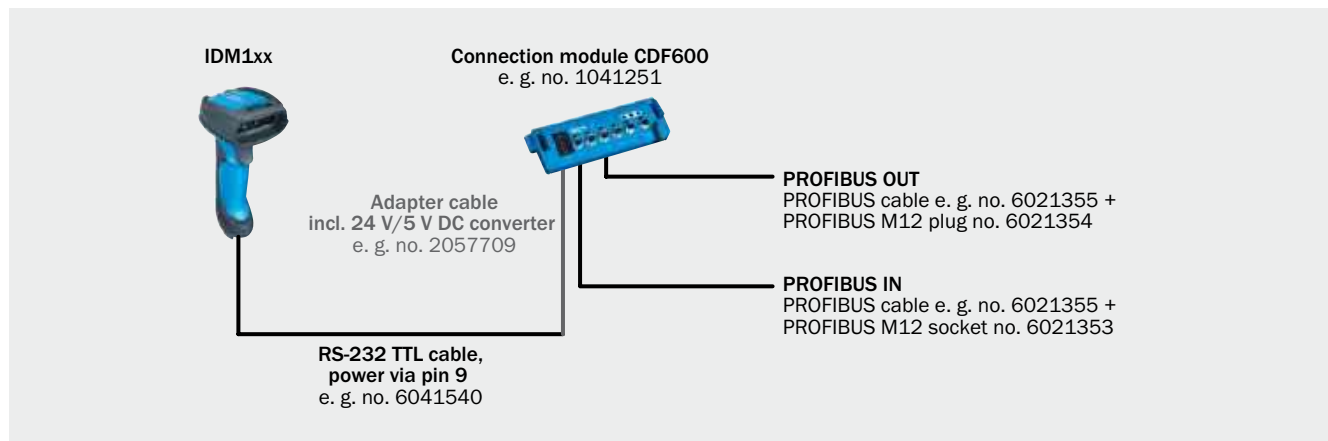

### Example of ProfiNet connection

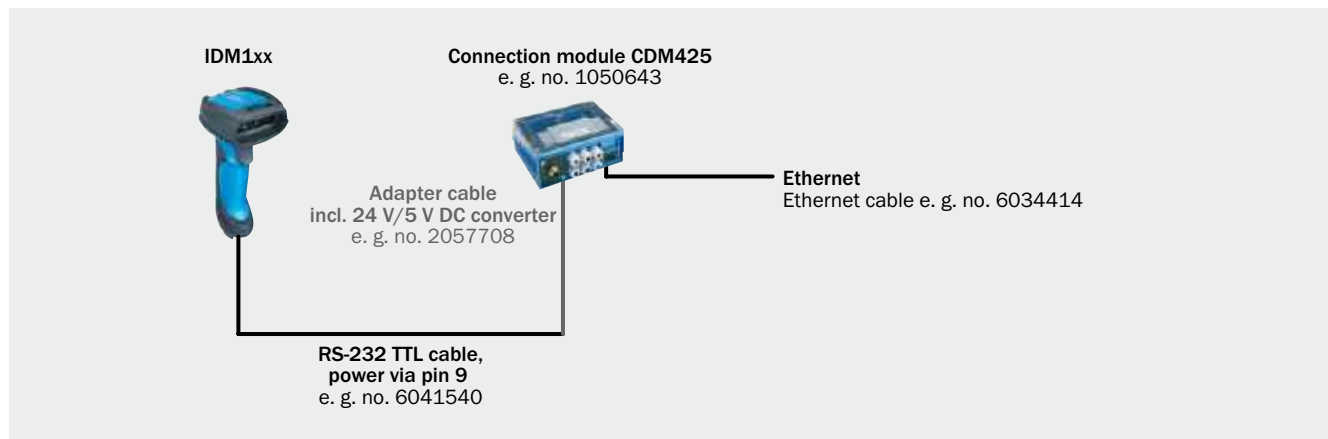

### Example of connection of “hand-held scanner as auxiliary input” to a CLV63x for example

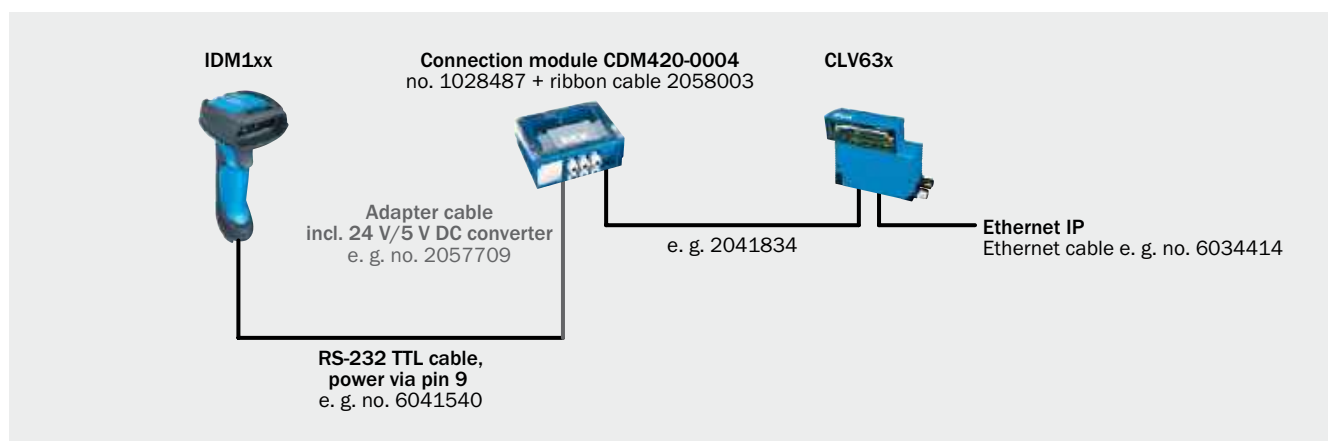

Adapter cables for hand-held scanner – connection module







	Brief description	Model name	Part no.	PROFIBUS via CDM/CMF	PROFIBUS via CDF	DeviceNet	Ethernet	AUX Input	ProfiNet
	<b>ProfiNet</b> Adapter cable (host) incl. 24 V/5 V DC converter for hand-held scanners, 9-pin D-Sub (RS-232) to CDM425 15-pin D-Sub, 0.3 m (plug/plug)	Adapter cable	2057708	-	-	-	-	-	●
	<b>PROFIBUS CDF, AUX Input, Ethernet, DeviceNet</b> Adapter cable (AUX) incl. 24-V/5-V DC converter for hand-held scanners, 9-pin D-sub (RS-232) to CDB620/CDM420/CDF600-0100 15-pin D-sub, 0.3 m (plug/plug)	Adapter cable	2057709	●	●	●	●	●	-

Connection cables for hand-held scanner to adapter cable

	Brief description	Model name	Part no.	IDM120	IDM140	IDM140-BT	IDM160	IDM160-BT
	Straightened RS-232 TTL cable, 1.8 m, power via pin 9	Connection cable (plug-socket)	6041540	●	●	●	-	●
	Straightened RS-232 TTL cable, 1.8 m, power via pin 9	Connection cable (plug-socket)	6045196	-	-	-	●	-
	Spiral cord RS-232 3.8 m (fully extracted), power via pin 9	Connection cable (plug-plug)	6039156	○	○	-	-	-
	Spiral cord RS-232 TTL 3.8 m (fully extracted), power via pin 9	Connection cable (plug-plug)	6045233	-	-	-	○	-

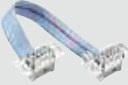
● = required, ○ = optional.

## Connection modules

	Brief description	Model name	Part no.	PROFIBUS via CDM/CMF	PROFIBUS via CDF	DeviceNet	Ethernet	AUX Input	ProfiNet
	Modular connection module for one sensor	CDM420-0001	1025362	●	-	●	●	-	-
Illustration may differ	Modular connection module for two sensors	CDM420-0004	1028487	-	-	-	-	●	-
	Modular connection module for one sensor, additional M12 socket for PROFINET on face plate	CDM425-00034094	1048488	-	-	-	-	-	●
Illustration may differ									
	Ribbon cable	Connection cable (plug-plug)	2058003	-	-	-	-	●	-
	PROFIBUS-DP Gateway (IP 20, 9-in. D-Sub socket)	CMF400-1001	1026241	●	-	-	-	-	-
Illustration may differ									
	DeviceNet Gateway (IP 65, M12 plug)	CMF400-2101	1026242	-	-	●	-	-	-
Illustration may differ	Ethernet TCP/IP Gateway (IP 65, RJ45 socket)	CMF400-3101	1026357	-	-	-	●	-	-
	Configuration and diagnosis adapter for CMF400	Programming Adapter (Compro)	2030490	●	-	●	●	-	-
	CDF600 fieldbus proxy to connect a IDM1xx to a PROFIBUS network	CDF600-0100	1041251	-	●	-	-	-	-



## Search online quickly and safely with the SICK “Finders”

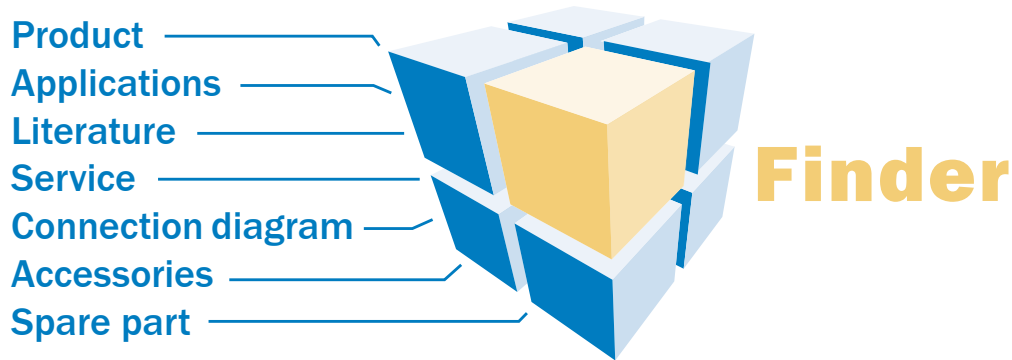

**Product Finder:** We can help you to quickly target the product that best matches your application.

**Applications Finder:** Select the application description on the basis of the challenge posed, industrial sector, or product group.

**Literature Finder:** Go directly to the operating instructions, technical information, and other literature on all aspects of SICK products.

These and other Finders at [www.mysick.com](http://www.mysick.com)

## Efficiency – with SICK e-commerce tools

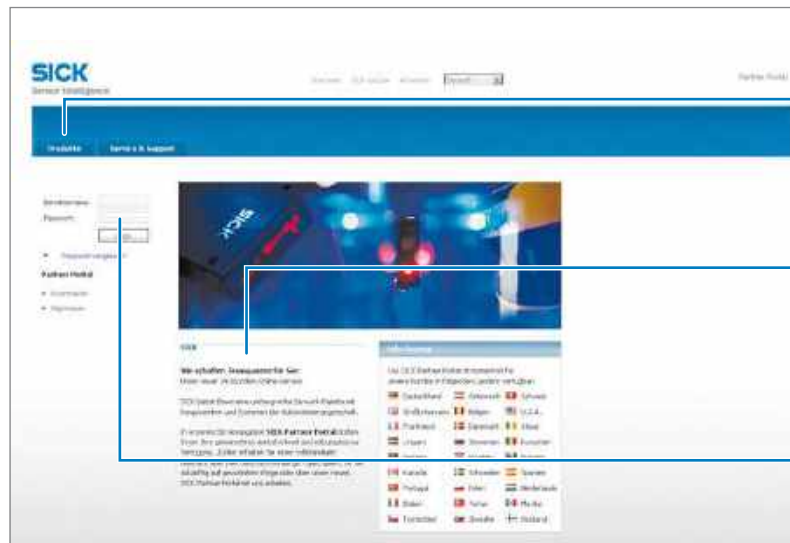

**Clearly structured:** You can find everything you need for your sensor planning under the menu items Products, Information, and My Account.

**Available 24 hours a day:** Regardless of where you are in the world or what you'd like to know – everything is just a click away at [www.mysick.com](http://www.mysick.com).

**Safe:** Your data is password-protected and only visible to you. With the individual user management, you define who can see what data and who can execute what actions.

### Find out prices and availability

Determine the price and possible delivery date of your desired product simply and quickly.

### Order online

You can go through the ordering process in just a few steps.

### Request or view a quote

You can have a quote generated online here. Every quote is confirmed to you via e-mail.

## SICK at a glance

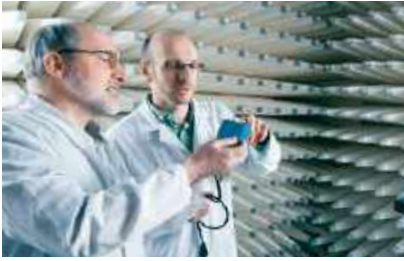

### Leading technologies

With a staff of more than 5,000 and over 50 subsidiaries and representations worldwide, SICK is one of the leading and most successful manufacturers of sensor technology. The power of innovation and solution competency have made SICK the global market leader. No matter what the project and industry may be, talking with an expert from SICK will provide you with an ideal basis for your plans – there is no need to settle for anything less than the best.

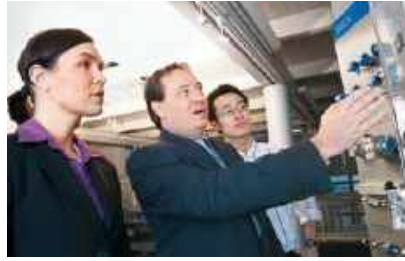

### Unique product range

- Non-contact detecting, counting, classifying, positioning and measuring of any type of object or media
- Accident and operator protection with sensors, safety software and services
- Automatic identification with bar code and RFID readers
- Laser measurement technology for detecting the volume, position and contour of people and objects
- Complete system solutions for analysis and flow measurement of gases and liquids



### Comprehensive services

- SICK LifeTime Services – for safety and productivity
- Application centers in Europe, Asia and North America for the development of system solutions under real-world conditions
- E-Business Partner Portal [www.mysick.com](http://www.mysick.com) – price and availability of products, requests for quotation and online orders

Worldwide presence with subsidiaries in the following countries:

Australia  
Belgium/Luxembourg  
Brasil  
Česká Republika  
Canada  
China  
Danmark  
Deutschland  
España  
France  
Great Britain  
India  
Israel  
Italia  
Japan

México  
Nederland  
Norge  
Österreich  
Polska  
România  
Russia  
Schweiz  
Singapore  
Slovenija  
South Africa  
South Korea  
Suomi  
Sverige  
Taiwan  
Türkiye  
United Arab Emirates  
USA

Please find detailed addresses and additional representatives and agencies in all major industrial nations at [www.sick.com](http://www.sick.com)